

Model MK 240 | Dynamic climate chambers for rapid temperature changes

The BINDER MK series chamber is suitable for all heat and cold tests between -40 °C and 180 °C. The MK is a clever alternative to complex individual solutions for cyclical temperature tests.

BENEFITS

- Homogeneous climate conditions thanks to APT.line™ technology
- Comprehensive programming and data acquisition
- Large heated viewing window



Model 240



Model 240

MAIN FEATURES

- Temperature range: -40 °C to 180 °C
- APT.line™ preheating chamber technology
- Programmable condensation protection for test material
- Heated viewing window with LED interior lighting
- BINDER Multi Management Software APT-COM™ Basic Edition
- Troubleshooting system with visual and audible alarms
- Intuitive touchscreen controller with time-segment and real-time programming
- Internal data logger, measured values can be read out in open format via USB
- Access port with silicone plug, 50 mm, left
- Class 2 independent adjustable temperature safety device (DIN 12880) with visual alarm
- 4 castors, two with brakes
- Computer interface: Ethernet
- 230 V power socket on the right-side control panel
- Adjustable ramp function
- Integrated chart recorder
- Real-time clock
- Door heating
- 1 stainless steel rack
- Inner chamber made of stainless steel
- CFC-free refrigerant R-452A
- Cooling with compressor cooling unit

ORDERING INFORMATION

Interior volume [L]	Voltage	Option model	Version	Art.-No.
Model MK 240				
228	400 V 3~ ph 50 Hz	Standard	MK240-400V	9020-0376
	480 V 3~ ph 60 Hz	with voltage and frequency converter	MK240-480V-C	9020-0355

TECHNICAL DATA

Description	MK240-400V ¹	MK240-480V-C ¹
Article Number	9020-0376	9020-0355
Performance Data Temperature		
Temperature range [°C]	-40...180	-40...180
Temperature variation depending on setpoint [± K]	0.1...1.2	0.1...1.2
Temperature fluctuation depending on setpoint [± K]	0.1...0.5	0.1...0.5
Average heating-up rate according to IEC 60068-3-5 [K/min]	5	5
Cooling down time from 180 °C to -40 °C [min]	110	110
Average cooling down time according to IEC 60068-3-5 [K/min]	4.5	4.5
Max. heat compensation at 25 °C [W]	2000	2000
Electrical data		
Rated Voltage [V]	400	480
Power frequency [Hz]	50	60
Nominal power [kW]	5.6	5.6
Unit fuse [A]	16	16
Phase (Nominal voltage)	3~	3~
Internal Dimensions		
Depth [mm]	443	443
Height [mm]	700	700
Width [mm]	735	735
Housing dimensions not incl. fittings and connections		
Width net [mm]	1115	1115
Height net [mm]	1710	1710
Depth net [mm]	925	925
Measures		
Viewing window width [mm]	508	508
Viewing window height [mm]	300	300
Wall clearance back [mm]	300	300
Wall clearance sidewise [mm]	200	200
Interior volume [L]	228	228
Net weight of the unit (empty) [kg]	340	340
permitted load [kg]	70	70
Load per rack [kg]	30	30
Doors		
Unit doors	1	1
Environment-specific data		
Sound-pressure level [dB(A)]	62	67
Fixtures		
Number of shelves (std./max.)	1/6	1/6

1 All technical data is specified for unloaded units with standard equipment at an ambient temperature of +22 °C ±3 °C and a power supply voltage fluctuation of ±10 %. The temperature data is determined in accordance to BINDER factory standard following DIN 12880, observing the recommended wall clearances of 10 % of the height, width, and depth of the inner chamber. Technical data refers to 100 % fan speed. All indications are average values, typical for units produced in series. We reserve the right to change technical specifications at any time.

DIMENSIONS incl. fittings and connections [mm]

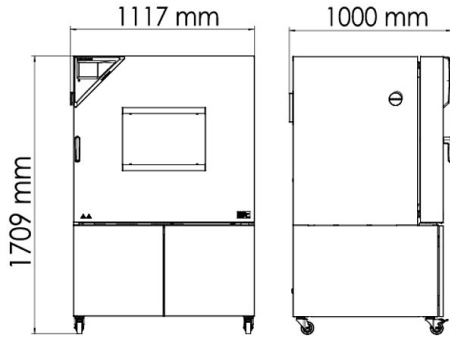

CHARTS

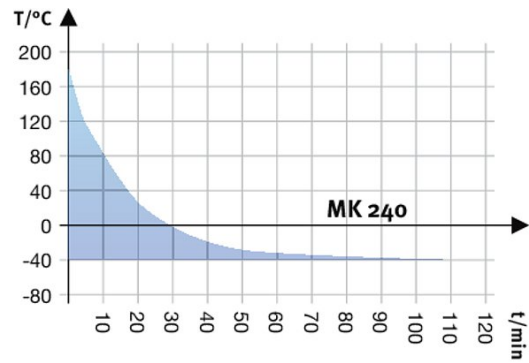
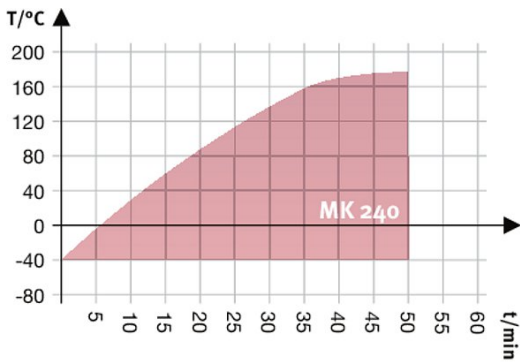

Heating up rate

Cooling down rate

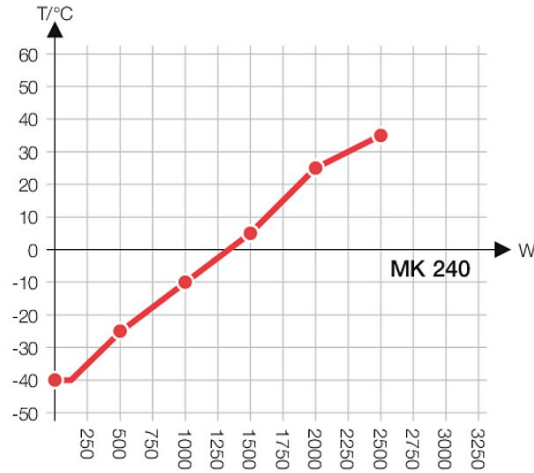

Heat compensation chart

OPTIONS AND ACCESSORIES

Designation	Description	*	Art.-No.
Access port	notch-type access port in door, 100 x 35 mm	-	8012-1850
	left		
	30 mm	01	8012-1322
	50 mm	01	8012-1328
	80 mm	01	8012-1334
	100 mm	01, 11	8012-1542
	125 mm	01, 11	8012-1351
	right		
Access port with silicone plug	30 mm	01	8012-1319
	50 mm	01	8012-1325
	80 mm	01	8012-1331
	100 mm	01, 11	8012-1539
	125 mm	01, 11	8012-1348
	top		
	80 mm	01	8012-1536
	100 mm	01, 11	8012-1530
	125 mm	01, 11	8012-1533
Analog output 4-20 mA	for temperature values (output not adjustable)	-	8012-1084
APT-COM™ 4 GLP-Edition	for working under GLP-compliant conditions. Measured values are documented in a tamper-proof way in line with the requirements of FDA Regulation 21 CFR 11. version 4, GLP edition	19	9053-0042
APT-COM™ 4 PROFESSIONAL-Edition	convenient unit and user management built on the BASIC edition. Suitable for networking up to 100 units. version 4, PROFESSIONAL edition	19	9053-0040
Calibration certificate, expanded	for temperature; for extending the measurement in center of chamber to include another test temperature	-	8012-1124
	for temperature, measurement in center of chamber at specified temperature	-	8012-1143
Calibration certificate, temperature	temperature measurement incl. certificate and 27 measuring points at specified temperature	-	8012-1602
	temperature measurement incl. certificate, 15- 18 measuring points at specified temperature	-	8012-1581
	temperature measurement incl. certificate, 9 measuring points at specified temperature	-	8012-1560
Data Logger Kit	T 220: For continuous temperature logging from -90 °C to 220 °C. The kit includes 1 data logger, Pt 100 sensor with 2 m extension cable and 1 magnetic fixture for mounting to the BINDER unit	19	8012-0715
Data Logger Software	LOG ANALYZE software kit, configuration and evaluation software for all BINDER Data Logger Kits (incl. USB data cable)	19	8012-0821
Door lock	lockable door handle	-	8012-1861
Dry-air purge	uncontrolled, incl. connection; for preventing condensation	-	8012-1865
Dry-air purge, connection	for the connection to an existing pressurized air network	-	8012-1089
pH-neutral detergent	concentrated, for gentle remove of residual contaminants; 1 kg	-	1002-0016
Pt 100 temperature sensor	additional flexible Pt 100, interior, for displaying the temperature on the unit display	-	8012-1093
Rack	stainless steel	-	6004-0097
Rack accessories	fasteners (1 set of 4) for additional security of racks	-	8012-0620
Rack, reinforced	stainless steel, with fasteners (1 set of 4)	-	8012-0605
RS 485 / RS 422 interface converter	RS 422 cable set and RS 485 / RS 422 interface converter for connection to 10-way plug distributor 115 V option model	-	8012-0599
	230 V option model	-	8012-0589
RS 485 interface, 2-wire	Additional serial interface can be used parallel to Ethernet, for Multi Management Software APT-COM™	-	8012-1768
Shelf, perforated	Stainless steel	-	8009-0447
Temperature safety device class 2	with visual alarm (DIN 12880)	-	8012-1792
Zero voltage relay contacts	for controlling 3 relay contacts via program regulators, accessible via 6-pin DIN socket (max. 24 V - 2.5 A)	-	8012-1095

* Notes › See last page

SERVICES

Designation	Description	*	Art.-No.
Installation services			
Installation	and set up of unit at operating location, connect to existing connections	13, 18	DL10-0300
Instruction	unit function instructions for operation and programming of the controller	18	DL10-0700
Preventive maintenance			
Preventive maintenance	Executive of equipment inspection according to maintenance plan	14, 18	DL20-0500
Calibration services			
Calibration temperature incl. certificate	including certificate, one measuring point in center of chamber at specified temperature	14, 16, 17, 18	DL30-0101
Temperature measurement 18 measuring points	including certificate, 18 measuring points at specified temperature	14, 16, 17, 18	DL30-0118
Temperature measurement 27 measuring points	including certificate, 27 measuring points at specified temperature	14, 16, 17, 18	DL30-0127
Temperature measurement 9 measuring points	including certificate, 9 measuring points at specified temperature	14, 16, 17, 18	DL30-0109
Validation services			
Execution of IQ/OQ	in accordance with qualification folder	15, 18, 20	DL41-0200
Execution of IQ/OQ/PQ	in accordance with customer's requirement, price: on request	15, 18	DL44-0500
Qualification folder IQ/OQ	supporting documents for validation performed by customer, consisting of: IQ/OQ checklists, unit schematics, QM certificate in accordance with ISO 9001	15, 18, 20	8012-0863
Qualification folder IQ/OQ/PQ	supporting documents for validation performed by customer, in accordance with customer's requirement, extension of Qualification folder IQ/OQ by chapter PQ	15, 18	8012-0951
Warranty service			
Extension of the warranty from 2 to 3 years	beginning with the date of delivery, wearing parts are not included	-	DL01-1041
Extension of the warranty from 2 to 5 years	beginning with the date of delivery, wearing parts are not included	-	DL01-1042

* Notes › See last page

Lithium ion battery cell testing chambers

The BINDER test chambers for aging and performance of lithium-ion energy storage devices offer maximum application convenience and meet Eucar/Hazard level 4*. BINDER supplies test chambers with a standard package for aging tests, as well as a more extensive package for carrying out performance and aging tests.



Pressure relief flap with an additional relieving spring as a safety measure in the event of faults

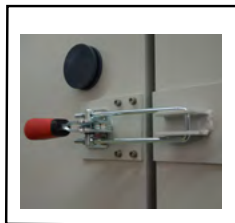

Door-locking mechanism with strong closing brackets on the side

Access port for introducing external measuring instruments



Eucar/
Hazard
Level 4*

Additional safety measures on the MK 240 dynamic climate chamber



Temperature range limited to 120 °C on the controller

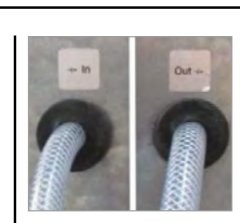

Inert gas connections for rinsing (e.g., for nitrogen)

PACKAGE P – FOR PERFORMANCE AND AGING TESTS

Application:

Cells and modules are tested at different temperatures **with and without a current supply** to measure performance.

Solution:

- Class 2 independent temperature safety device when temperature is set to 120 °C
- Temperature range limited to 120 °C on the controller
- Stainless steel pressure relief flap installed in the middle of the top of the unit
- Enhanced door lock mechanism with reinforced brackets
- Inert gas connections



PACKAGE A – FOR AGING TESTS

Application:

Cells and modules are tested at different temperatures always **without a current supply** in order to assess aging during storage.

Solution:

- Class 2 independent temperature safety device when temperature is set to 120 °C.
- Temperature range limited to 120 °C on the controller

FURTHER ADJUSTMENTS AVAILABLE ON REQUEST:

BINDER series units are converted by our BINDER INDIVIDUAL department according to special customer requirements, and equipped with additional functions.



Program sequence display using indicator lamps



Electromechanical door lock mechanism controlled in a program and/or manually

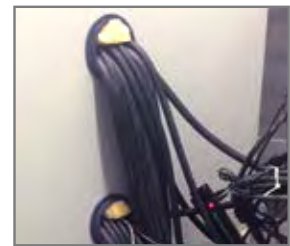

Additional access ports available in almost all sizes and locations

TIPS AND TRICKS



Learn more in our user report:

TÜV SÜD Battery Testing GmbH -
Energy storage device in hardness test

› go2binder.com/en-TUEV-SUED-Battery-Testing

Find out more ›



WolfLabs

Pricing on any accessories shown can be found by keying the part number into the search box on our website.

The specifications listed in this brochure are subject to change by the manufacturer and therefore cannot be guaranteed to be correct. If there are aspects of the specification that must be guaranteed, please provide these to our sales team so that details can be confirmed.

www.wolflabs.co.uk

Tel : 01759 301142

Fax : 01759 301143

sales@wolflabs.co.uk

Please contact us if this literature doesn't answer all your questions.